











*Black frame product can be provided upon request.

1500 V CS6K-275 | 280 | 285 M

Canadian Solar's new 1500 V module is a product for high voltage systems, which can increase the string length of solar systems by up to 50%, saving BOS costs.

KEY FEATURES

-  **1500V** Designed for high voltage systems of up to 1500 V_{DC}, saving on BoS costs
-  Excellent module efficiency of up to 17.41 %
-  Cell efficiency of up to 20.0 %
-  **No. 1 PTC** High PTC rating of up to 90.7%
-  Outstanding low irradiance performance: 96.5 %
-  **IP67** IP67 junction box for long-term weather endurance
-  ******* Heavy snow load up to 5400 Pa, wind load up to 2400 Pa

-  **25 years** linear power output warranty
-  **10 years** product warranty on materials and workmanship

MANAGEMENT SYSTEM CERTIFICATES*

ISO 9001:2008 / Quality management system
ISO 14001:2004 / Standards for environmental management system
OHSAS 18001:2007 / International standards for occupational health & safety

PRODUCT CERTIFICATES*

IEC 61215 / IEC 61730: VDE / CE
UL 1703 / IEC 61215 performance: CEC listed (US)
UL 1703: CSA / IEC 61701 ED2: VDE / IEC 62716: VDE / Take-e-way



* As there are different certification requirements in different markets, please contact your local Canadian Solar sales representative for the specific certificates applicable to the products in the region in which the products are to be used.

CANADIAN SOLAR INC. is committed to providing high quality solar products, solar system solutions and services to customers around the world. As a leading PV project developer and manufacturer of solar modules with over 15 GW deployed around the world since 2001, Canadian Solar Inc. (NASDAQ: CSIQ) is one of the most bankable solar companies worldwide.

CANADIAN SOLAR INC.

545 Speedvale Avenue West, Guelph, Ontario N1K 1E6, Canada, www.canadiansolar.com, support@canadiansolar.com

ENGINEERING DRAWING (mm)

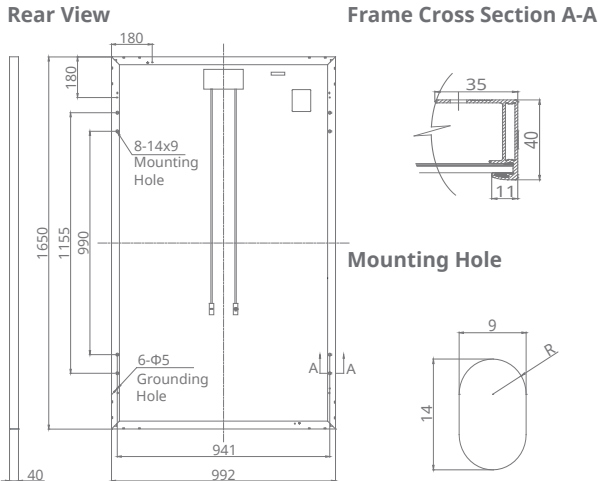

CS6K-280M / I-V CURVES

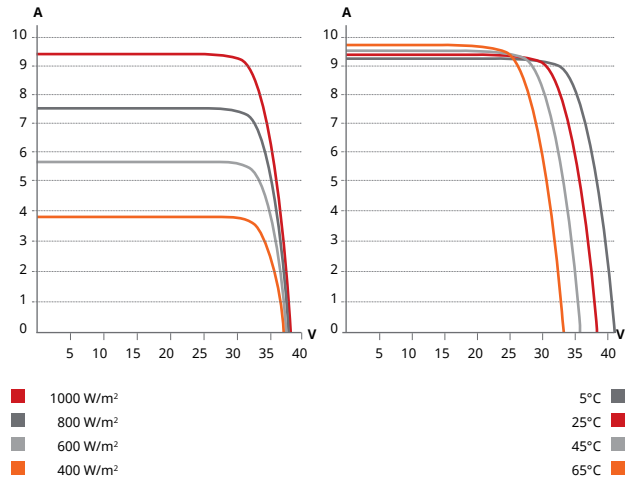

ELECTRICAL DATA | STC*

CS6K	275 M	280 M	285 M
Nominal Max. Power (Pmax)	275 W	280 W	285 W
Opt. Operating Voltage (Vmp)	31.3 V	31.5 V	31.7 V
Opt. Operating Current (Imp)	8.80 A	8.89 A	8.98 A
Open Circuit Voltage (Voc)	38.3 V	38.5 V	38.6 V
Short Circuit Current (Isc)	9.31 A	9.43 A	9.51 A
Module Efficiency	16.80 %	17.11 %	17.41 %
Operating Temperature	-40°C ~ +85°C		
Max. System Voltage	1500 V (IEC) or 1500 V (UL)		
Module Fire Performance	TYPE 1 (UL 1703) or CLASS C (IEC 61730)		
Max. Series Fuse Rating	15 A		
Application Classification	Class A		
Power Tolerance	0 ~ + 5 W		

* Under Standard Test Conditions (STC) of irradiance of 1000 W/m², spectrum AM 1.5 and cell temperature of 25°C.

ELECTRICAL DATA | NOCT*

CS6K	275 M	280 M	285 M
Nominal Max. Power (Pmax)	199 W	202 W	206 W
Opt. Operating Voltage (Vmp)	28.5 V	28.7 V	28.9 V
Opt. Operating Current (Imp)	6.95 A	7.04 A	7.12 A
Open Circuit Voltage (Voc)	35.1 V	35.3 V	35.4 V
Short Circuit Current (Isc)	7.54 A	7.63 A	7.70 A

* Under Nominal Operating Cell Temperature (NOCT), irradiance of 800 W/m², spectrum AM 1.5, ambient temperature 20°C, wind speed 1 m/s.

PERFORMANCE AT LOW IRRADIANCE

Outstanding performance at low irradiance, average relative efficiency of 96.5 % from an irradiance of 1000 W/m² to 200 W/m² (AM 1.5, 25°C).

The specification and key features described in this datasheet may deviate slightly and are not guaranteed. Due to on-going innovation, research and product enhancement, Canadian Solar Inc. reserves the right to make any adjustment to the information described herein at any time without notice. Please always obtain the most recent version of the datasheet which shall be duly incorporated into the binding contract made by the parties governing all transactions related to the purchase and sale of the products described herein.

Caution: For professional use only. The installation and handling of PV modules requires professional skills and should only be performed by qualified professionals. Please read the safety and installation instructions before using the modules.

MECHANICAL DATA

Specification	Data
Cell Type	Mono-crystalline, 6 inch
Cell Arrangement	60 (6 × 10)
Dimensions	1650 × 992 × 40 mm (65.0 × 39.1 × 1.57 in)
Weight	18.2 kg (40.1 lbs)
Front Cover	3.2 mm tempered glass
Frame Material	Anodized aluminium alloy
J-Box	IP67, 3 diodes
Cable	PV1500DC-F1 4 mm² (IEC) & 12 AWG 2000 V (UL)
Connector	T4-1500V or PV2 series or H4-UTX
Per Pallet	26 pieces, 520 kg (1146.4 lbs)
Per container (40' HQ)	728 pieces

TEMPERATURE CHARACTERISTICS

Specification	Data
Temperature Coefficient (Pmax)	-0.41 % / °C
Temperature Coefficient (Voc)	-0.31 % / °C
Temperature Coefficient (Isc)	0.053 % / °C
Nominal Operating Cell Temperature	45 ± 2 °C

PARTNER SECTION

