









## MAXPOWER (1500 V) CS6U-325 | 330 | 335 | 340P

Canadian Solar's new 1500 V module is a product for high voltage systems, which can increase the string length of solar systems by up to 50%, saving BOS cost.

### KEY FEATURES

- 
**1500V** Designed for high voltage systems of up to 1500 V<sub>DC</sub>, saving on BoS cost
- 
**+** Excellent module efficiency of up to: 17.49 %
- 
**☁** Outstanding low irradiance performance: 96.0 %
- 
**No. 1 PTC** High PTC rating of up to: 92.21 %
- 
**☂** IP68 junction box for long-term weather endurance
- 
**\*\*\*** Heavy snow load up to 5400 Pa, wind load up to 2400 Pa



**linear power output warranty**



**product warranty on materials and workmanship**

### MANAGEMENT SYSTEM CERTIFICATES\*

ISO 9001:2008 / Quality management system  
 ISO 14001:2004 / Standards for environmental management system  
 OHSAS 18001:2007 / International standards for occupational health & safety

### PRODUCT CERTIFICATES\*

IEC 61215 / IEC 61730: VDE / MCS / CE  
 UL 1703 / IEC 61215 performance: CEC listed (US)  
 UL 1703: CSA / IEC 61701 ED2: VDE / IEC 62716: VDE  
 UNI 9177 Reaction to Fire: Class 1  
 IEC 60068-2-68: SGS  
 Take-e-way



\* Please contact your local Canadian Solar sales representative for the specific product certificates applicable in your market.

**CANADIAN SOLAR INC.** is committed to providing high quality solar products, solar system solutions and services to customers around the world. As a leading PV project developer and manufacturer of solar modules with over 21 GW deployed around the world since 2001, Canadian Solar Inc. (NASDAQ: CSIQ) is one of the most bankable solar companies worldwide.

### CANADIAN SOLAR INC.

545 Speedvale Avenue West, Guelph, Ontario N1K 1E6, Canada, [www.canadiansolar.com](http://www.canadiansolar.com), [support@canadiansolar.com](mailto:support@canadiansolar.com)

## ENGINEERING DRAWING (mm)

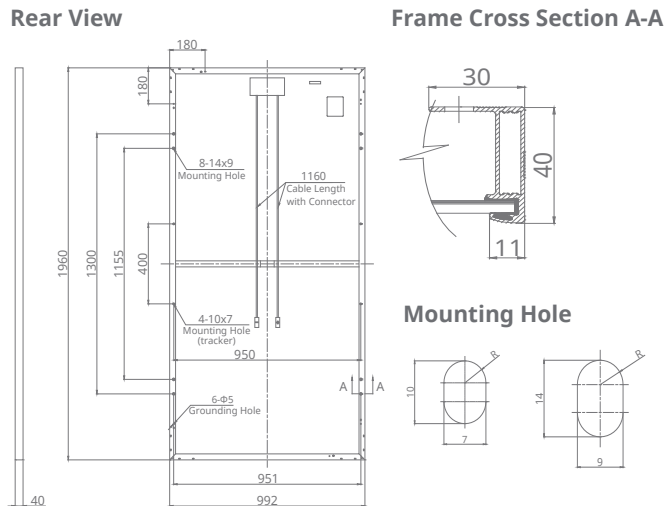

## CS6U-330P / I-V CURVES

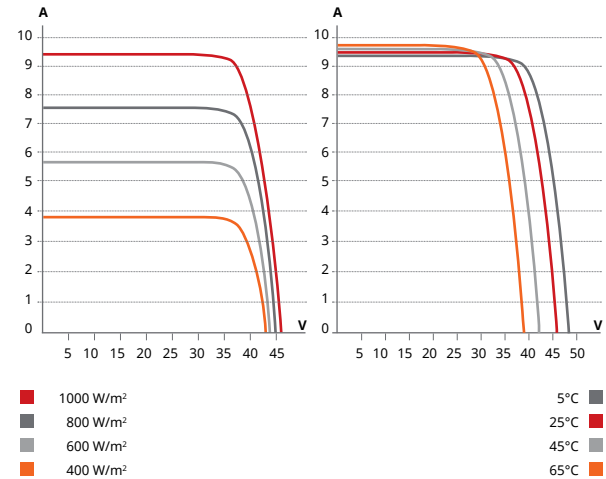

## ELECTRICAL DATA | STC\*

CS6U	325P	330P	335P	340P
Nominal Max. Power (Pmax)	325 W	330 W	335 W	340 W
Opt. Operating Voltage (Vmp)	37.0 V	37.2 V	37.4 V	37.6 V
Opt. Operating Current (Imp)	8.78 A	8.88 A	8.96 A	9.05 A
Open Circuit Voltage (Voc)	45.5 V	45.6 V	45.8 V	45.9 V
Short Circuit Current (Isc)	9.34 A	9.45 A	9.54 A	9.62 A
Module Efficiency	16.72%	16.97%	17.23%	17.49%
Operating Temperature	-40°C ~ +85°C			
Max. System Voltage	1500 V (IEC) or 1500 V (UL)			
Module Fire Performance	TYPE 1 (UL 1703) or CLASS C (IEC 61730)			
Max. Series Fuse Rating	15 A			
Application Classification	Class A			
Power Tolerance	0 ~ + 5 W			

\* Under Standard Test Conditions (STC) of irradiance of 1000 W/m<sup>2</sup>, spectrum AM 1.5 and cell temperature of 25°C.

## ELECTRICAL DATA | NMOT\*

CS6U	325P	330P	335P	340P
Nominal Max. Power (Pmax)	239 W	242 W	246 W	250 W
Opt. Operating Voltage (Vmp)	34.0 V	34.2 V	34.4 V	34.6 V
Opt. Operating Current (Imp)	7.01 A	7.08 A	7.15 A	7.22 A
Open Circuit Voltage (Voc)	42.4 V	42.5 V	42.6 V	42.7 V
Short Circuit Current (Isc)	7.54 A	7.63 A	7.70 A	7.77 A

\* Under Nominal Module Operating Temperature (NMOT), irradiance of 800 W/m<sup>2</sup>, spectrum AM 1.5, ambient temperature 20°C, wind speed 1 m/s.

## PERFORMANCE AT LOW IRRADIANCE

Outstanding performance at low irradiance, with an average relative efficiency of 96.0 % for irradiances between 200 W/m<sup>2</sup> and 1000 W/m<sup>2</sup> (AM 1.5, 25°C).

The aforesaid datasheet only provides the general information on Canadian Solar products and, due to the on-going innovation and improvement, please always contact your local Canadian Solar sales representative for the updated information on specifications, key features and certification requirements of Canadian Solar products in your region.

Please be kindly advised that PV modules should be handled and installed by qualified people who have professional skills and please carefully read the safety and installation instructions before using our PV modules.

## MECHANICAL DATA

Specification	Data
Cell Type	Poly-crystalline, 6 inch
Cell Arrangement	72 (6 × 12)
Dimensions	1960 × 992 × 40 mm (77.2 × 39.1 × 1.57 in)
Weight	22.4 kg (49.4 lbs)
Front Cover	3.2 mm tempered glass
Frame Material	Anodized aluminium alloy
J-Box	IP68, 3 diodes
Cable	4.0 mm <sup>2</sup> (IEC), 12 AWG (UL), 1160 mm (45.7 in)
Connector	T4 series
Per Pallet	26 pieces, 635 kg (1400 lbs)
Per Container (40' HQ)	624 pieces

## TEMPERATURE CHARACTERISTICS

Specification	Data
Temperature Coefficient (Pmax)	-0.41 % / °C
Temperature Coefficient (Voc)	-0.31 % / °C
Temperature Coefficient (Isc)	0.05 % / °C
Nominal Module Operating Temperature (NMOT)	43 ± 2 °C

## PARTNER SECTION

